

# 110V, 52A, 16mΩ N-channel Power SGT MOSFET

## JMSH1118TC

### Features

- Excellent  $R_{DS(ON)}$  and Low Gate Charge
- 100% UIS Tested
- 100%  $\Delta V_{ds}$  Tested
- Halogen-free; RoHS-compliant

### Applications

- Load Switch
- PWM Application
- Power Management

### Product Summary

Parameters	Value	Unit
$V_{DSS}$	110	V
$V_{GS(th\_Typ)}$	3.2	V
$I_D(@V_{GS}=10V)$	52	A
$R_{DS(ON)\_Typ}(@V_{GS}=10V)$	16	mΩ

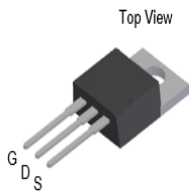

TO-220-3L

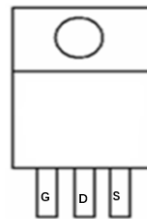
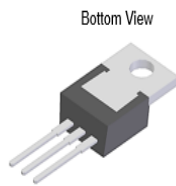

Pin Assignment

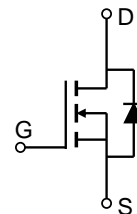

Schematic Diagram

### Ordering Information

Device	Marking	MSL	Form	Package	Tube(pcs)	Per Carton (pcs)
JMSH1118TC-U	SH1118T	NA	Tube	TO-220-3L	50	5000

### Absolute Maximum Ratings (@ $T_C = 25^\circ\text{C}$ unless otherwise specified)

Symbol	Parameter	Value	Unit
$V_{DS}$	Drain-to-Source Voltage	110	V
$V_{GS}$	Gate-to-Source Voltage	$\pm 20$	V
$I_D$	Continuous Drain Current	$T_C = 25^\circ\text{C}$	52
		$T_C = 100^\circ\text{C}$	33
$I_{DM}$	Pulsed Drain Current <sup>(1)</sup>	Refer to Fig.4	A
$E_{AS}$	Single Pulsed Avalanche Energy <sup>(2)</sup>	74	mJ
$P_D$	Power Dissipation	$T_C = 25^\circ\text{C}$	104
		$T_C = 100^\circ\text{C}$	42
$T_J, T_{STG}$	Junction & Storage Temperature Range	-55 to 150	$^\circ\text{C}$

### Thermal Characteristics

Symbol	Parameter	Max	Unit
$R_{\theta JA}$	Thermal Resistance, Junction to Ambient <sup>(3)</sup>	42	$^\circ\text{C}/\text{W}$
$R_{\theta JC}$	Thermal Resistance, Junction to Case	1.2	

**Electrical Characteristics** ( $T_J = 25^\circ\text{C}$  unless otherwise specified)

Symbol	Parameter	Conditions	Min.	Typ.	Max.	Unit
<b>Off Characteristics</b>						
$V_{(BR)DSS}$	Drain-Source Breakdown Voltage	$I_D = 250\mu\text{A}$ , $V_{GS} = 0\text{V}$	110	-	-	V
$I_{DSS}$	Zero Gate Voltage Drain Current	$V_{DS} = 88\text{V}$ , $V_{GS} = 0\text{V}$	-	-	1.0	$\mu\text{A}$
$I_{GSS}$	Gate-Body Leakage Current	$V_{DS} = 0\text{V}$ , $V_{GS} = \pm 20\text{V}$	-	-	$\pm 100$	nA
<b>On Characteristics</b>						
$V_{GS(th)}$	Gate Threshold Voltage	$V_{DS} = V_{GS}$ , $I_D = 250\mu\text{A}$	2.2	3.2	4.1	V
$R_{DS(ON)}$	Static Drain-Source ON-Resistance <sup>(4)</sup>	$V_{GS} = 10\text{V}$ , $I_D = 20\text{A}$	-	16	20	m $\Omega$
<b>Dynamic Characteristics</b>						
$R_g$	Gate Resistance	$f = 1\text{MHz}$	-	1.2	-	$\Omega$
$C_{iss}$	Input Capacitance	$V_{GS} = 0\text{V}$ , $V_{DS} = 55\text{V}$ , $f = 1\text{MHz}$	-	838	1256	pF
$C_{oss}$	Output Capacitance		-	254	381	pF
$C_{rss}$	Reverse Transfer Capacitance		-	8.4	-	pF
$Q_g$	Total Gate Charge	$V_{GS} = 0$ to $10\text{V}$ $V_{DS} = 55\text{V}$ , $I_D = 20\text{A}$	-	14	-	nC
$Q_{gs}$	Gate Source Charge		-	5	-	nC
$Q_{gd}$	Gate Drain ("Miller") Charge		-	4	-	nC
<b>Switching Characteristics</b>						
$t_{d(on)}$	Turn-On Delay Time	$V_{GS} = 10\text{V}$ , $V_{DD} = 55\text{V}$ $I_D = 20\text{A}$ , $R_{GEN} = 3\Omega$	-	8.5	-	ns
$t_r$	Turn-On Rise Time		-	19	-	ns
$t_{d(off)}$	Turn-Off Delay Time		-	14	-	ns
$t_f$	Turn-Off Fall Time		-	4.7	-	ns
<b>Body Diode Characteristics</b>						
$I_S$	Maximum Continuous Body Diode Forward Current		-	-	52	A
$I_{SM}$	Maximum Pulsed Body Diode Forward Current		-	-	207	A
$V_{SD}$	Body Diode Forward Voltage	$V_{GS} = 0\text{V}$ , $I_S = 20\text{A}$	-	-	1.2	V
$t_{rr}$	Body Diode Reverse Recovery Time	$I_F = 20\text{A}$ , $di/dt = 100\text{A}/\mu\text{s}$	22	36	54	ns
$Q_{rr}$	Body Diode Reverse Recovery Charge		-	46	-	nC

- Notes:
1. Repetitive Rating: Pulse Width Limited by Maximum Junction Temperature.
  2.  $E_{AS}$  condition: Starting  $T_J = 25^\circ\text{C}$ ,  $V_{DD} = 55\text{V}$ ,  $V_{GS} = 10\text{V}$ ,  $R_G = 25\text{ohm}$ ,  $L = 3\text{mH}$ ,  $I_{AS} = 7\text{A}$ ,  $V_{DD} = 0\text{V}$  during time in avalanche.
  3.  $R_{\theta JA}$  is measured with the device mounted on a  $1\text{inch}^2$  pad of 2oz copper FR4 PCB.
  4. Pulse Test: Pulse Width  $\leq 300\mu\text{s}$ , Duty Cycle  $\leq 0.5\%$ .



## Typical Performance Characteristics

Figure 1: Power De-rating

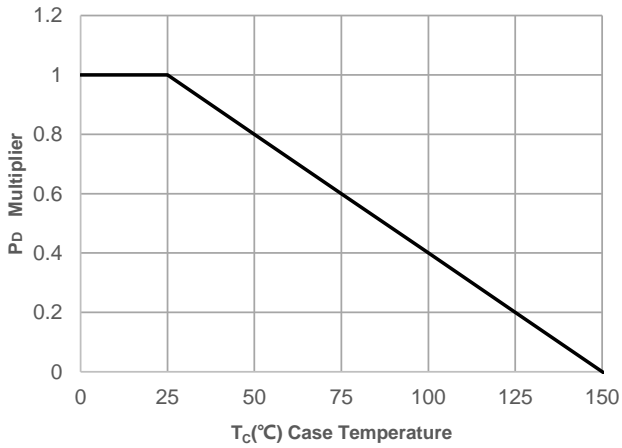

Figure 2: Current De-rating

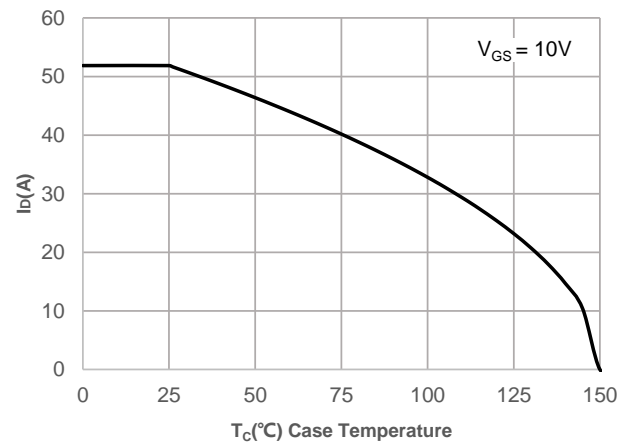

Figure 3: Normalized Maximum Transient Thermal Impedance

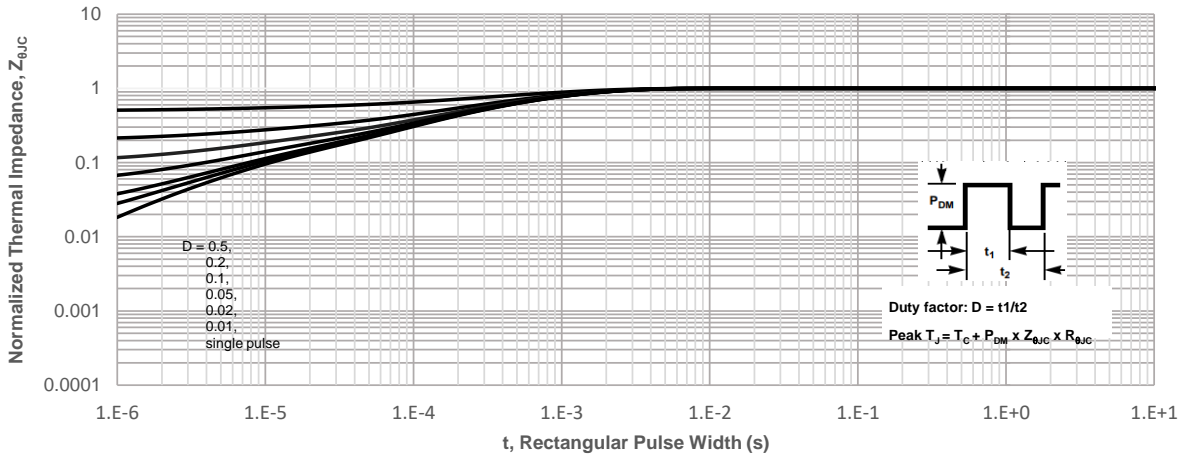
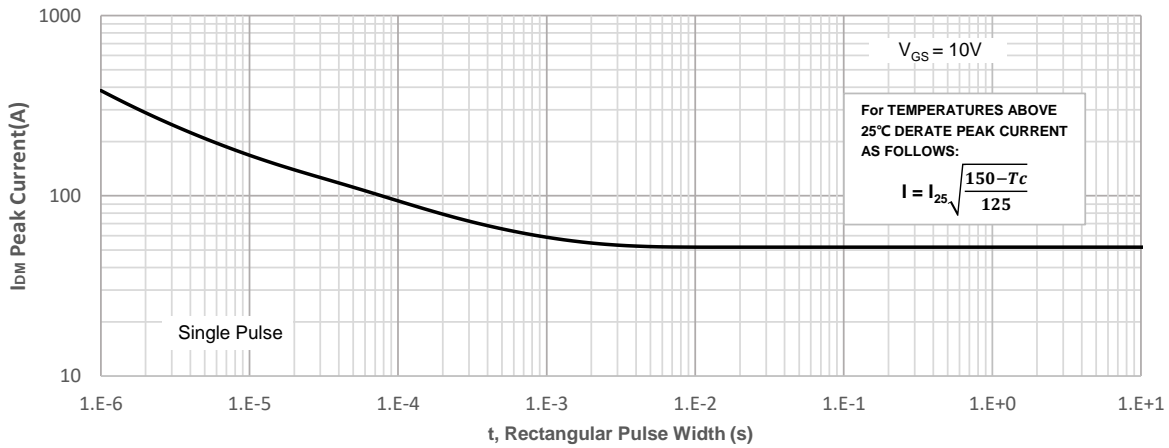
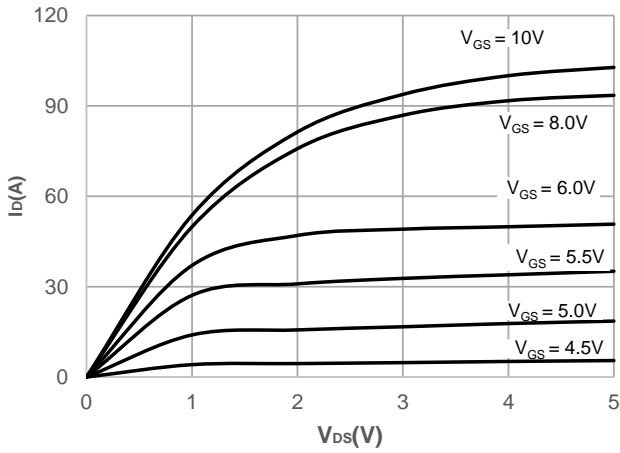
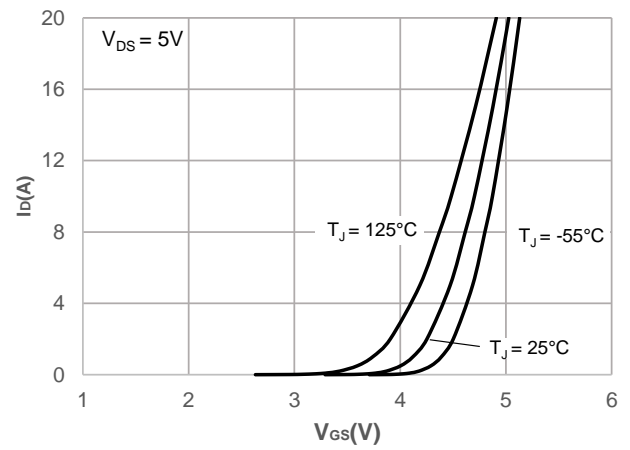
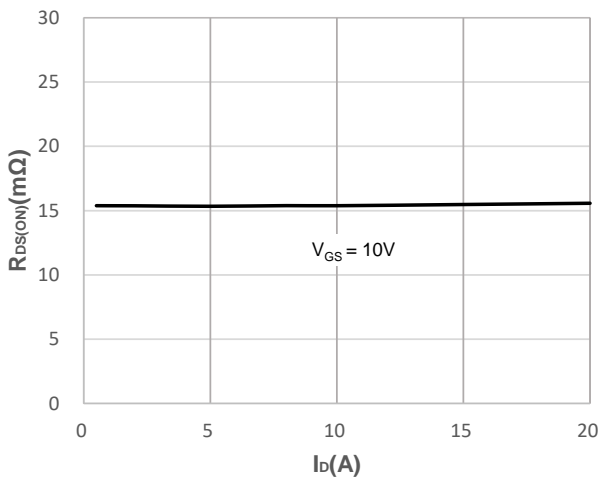
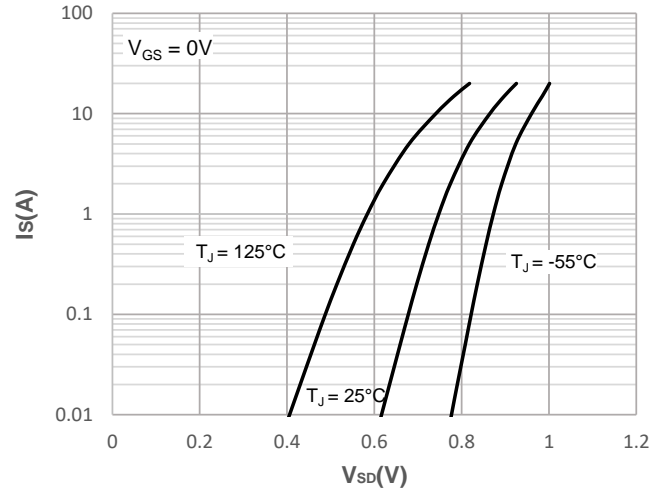
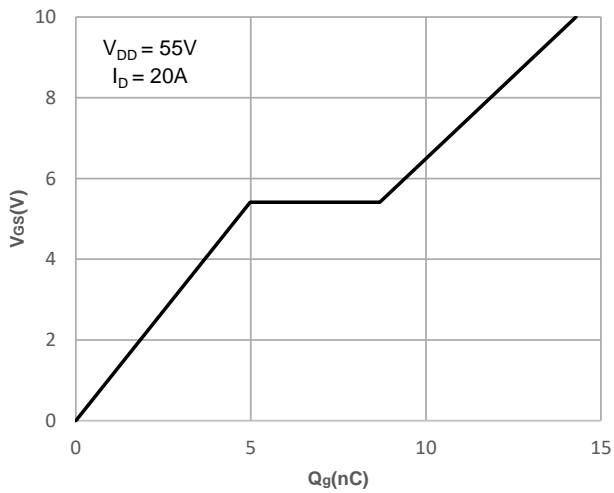
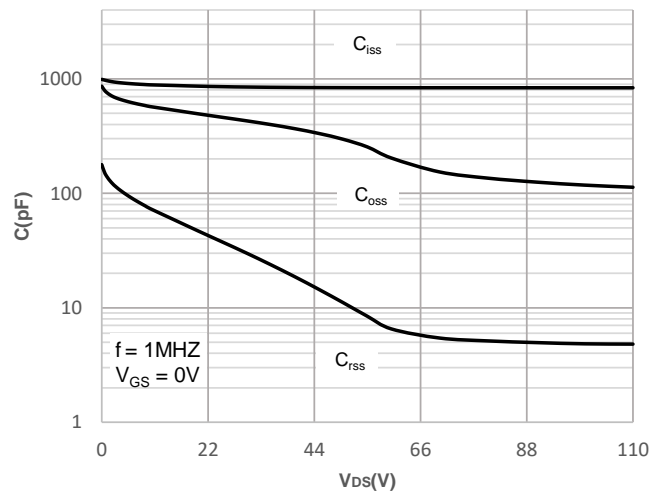

Figure 4: Peak Current Capacity



## Typical Performance Characteristics

**Figure 5: Output Characteristics**

**Figure 6: Typical Transfer Characteristics**

**Figure 7: On-resistance vs. Drain Current**

**Figure 8: Body Diode Characteristics**

**Figure 9: Gate Charge Characteristics**

**Figure 10: Capacitance Characteristics**

## Typical Performance Characteristics

Figure 11: Normalized Breakdown voltage vs. Junction Temperature

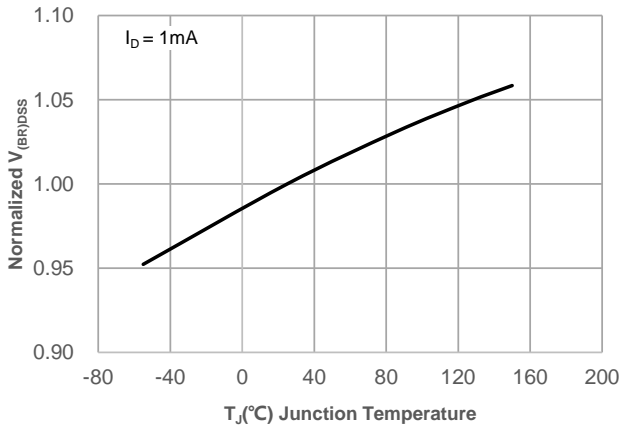

Figure 12: Normalized on Resistance vs. Junction Temperature

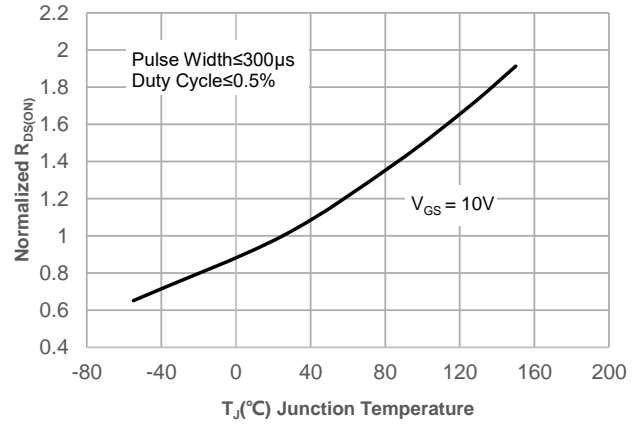

Figure 13: Normalized Threshold Voltage vs. Junction Temperature

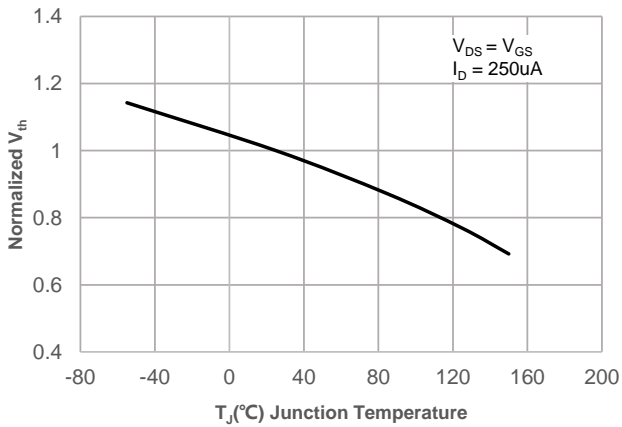

Figure 14:  $R_{DS(ON)}$  vs.  $V_{GS}$

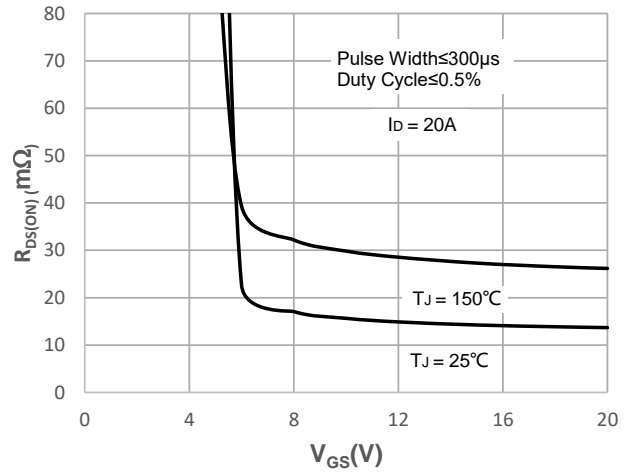
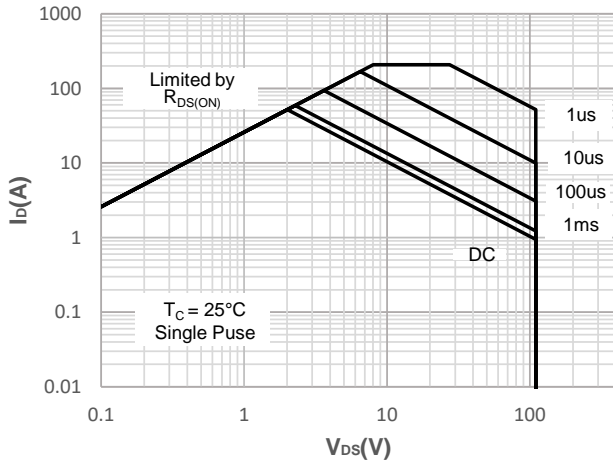

Figure 15: Maximum Safe Operating Area



**Test Circuit**

**Figure 1: Gate Charge Test Circuit & Waveform**

**Figure 2: Resistive Switching Test Circuit & Waveform**

**Figure 3: Unclamped Inductive Switching Test Circuit & Waveform**

**Figure 4: Diode Recovery Test Circuit & Waveform**

## Package Mechanical Data(TO-220-3L)

### Package Outline

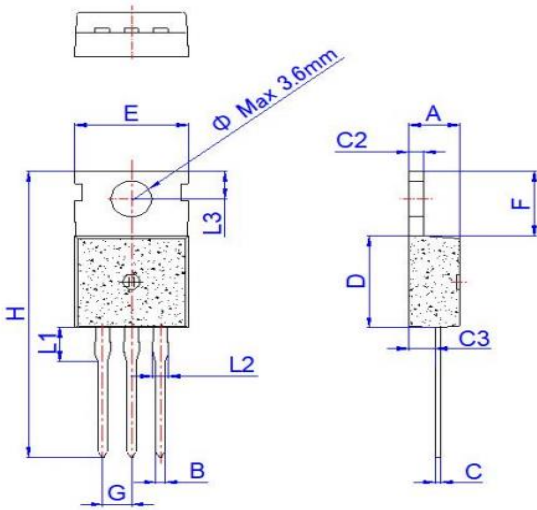

Ref.	Dimensions					
	Millimeters			Inches		
	Min.	Typ.	Max.	Min.	Typ.	Max.
A	4.40		4.60	0.173		0.181
B	0.70		0.90	0.028		0.035
C	0.45		0.60	0.018		0.024
C2	1.23		1.32	0.048		0.052
C3	2.20		2.60	0.087		0.102
D	8.90		9.90	0.350		0.390
E	9.90		10.3	0.390		0.406
F	6.30		6.90	0.248		0.272
G		2.54			0.1	
H	28.0		29.8	1.102		1.173
L1		3.39			0.133	
L2	1.14		1.70	0.045		0.067
L3	2.65		2.95	0.104		0.116
Φ		3.6			0.142	

Information furnished in this document is believed to be accurate and reliable. However, Jiangsu JieJie Microelectronics Co.,Ltd assumes no responsibility for the consequences of use without consideration for such information nor use beyond it. Information mentioned in this document is subject to change without notice, apart from that when an agreement is signed, Jiangsu JieJie complies with the agreement. Products and information provided in this document have no infringement of patents. Jiangsu JieJie assumes no responsibility for any infringement of other rights of third parties which may result from the use of such products and information.

is a registered trademark of Jiangsu JieJie Microelectronics Co.,Ltd.

